

Specific Item Installation	Pages	Steps
Panel / Hinge Installation - - - - -	4 - 14	001 - 042
Electrical - Duplex Outlets and Jumpers - - - - -	14 - 15	043 - 045
Panel Metal Raceway Dividers - - - - -	15 - 16	046 - 050
Panel / Base Raceway and Shrouds - - - - -	16 - 20	051 - 067
Base Raceway / Data Jacks - - - - -	20 - 21	068 - 069
Post Fillers / Inline Power Data Pole - - - - -	21 - 24	071 - 084
Double Channel Power Data Pole - - - - -	25 - 29	085 - 103
Flipper Door Unit / Mid Height Shelf - - - - -	29 - 32	104 - 113
Task Light - - - - -	32 - 33	114 - 117
Counter Top Brackets - - - - -	33 - 34	118 - 123
Cantilevers and Side Support / Rear Brackets - - - - -	34 - 36	124 - 132
Flat Plates - - - - -	37 - 37	133 - 133
Structural Pedestals - - - - -	37 - 37	134 - 136
Tack Boards - - - - -	38 - 38	137 - 138
NON-Photo Installation Instructions (Smaller packages for direct / specific printing)		
Panel Installation - - - - -	40 - 47	145 - 176
Fabric Stack On Panels- - - - -	48 - 49	177 - 182
Glass Stack On Panels- - - - -	50 - 51	185 - 192
Inline Power Poles / Post Fillers - - - - -	52 - 53	193 - 200
Rolling Privacy Screens / Top Track Bars - - - - -	54 - 55	201 - 208
Rolling Privacy Screens Lock Kit - - - - -	56 - 57	209 - 213

Common 4 Pack Configuration

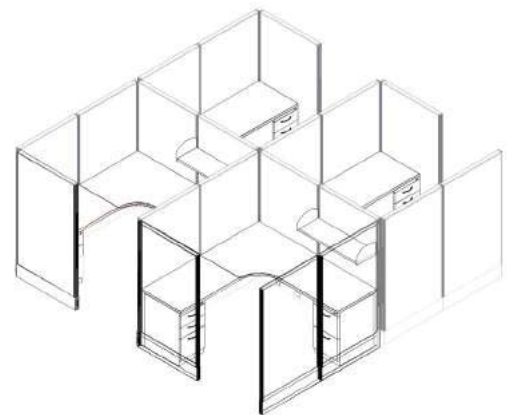
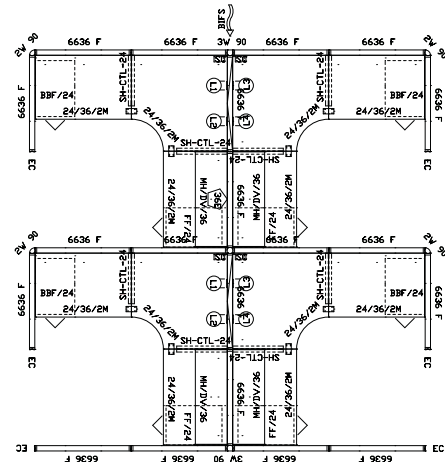

NOTE: The Table of Contents, Legend and Overview pages exist in many guides. Only the main installation guide contains all of the above information. Some smaller sections may begin with these pages, but be more specific in content. Please visit the AIS homepage to download any additional guides, or the comprehensive main guide.

System Symbols will have different numbers associated with them detailing dimensions. Below are some of the most common symbol types, with descriptions.

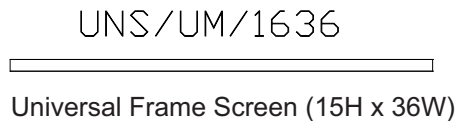
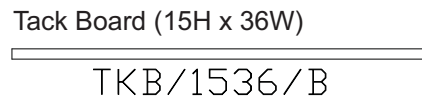
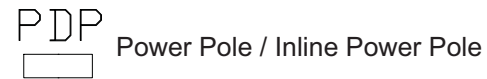
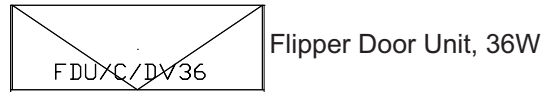
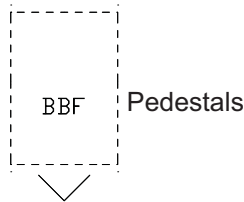
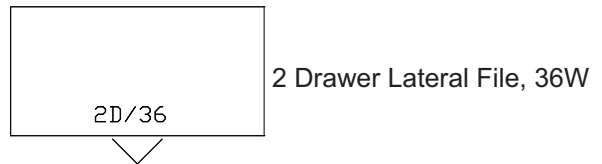
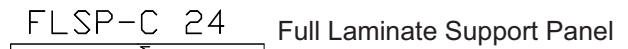
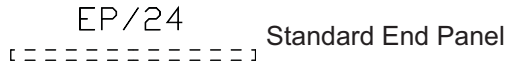
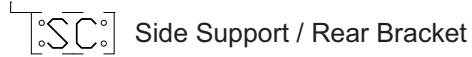
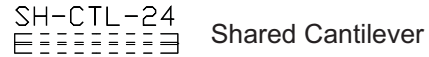
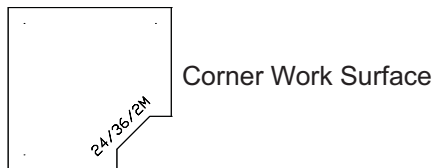
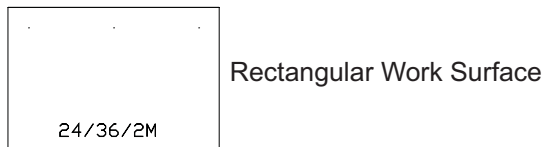
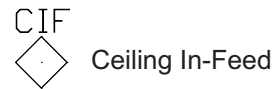
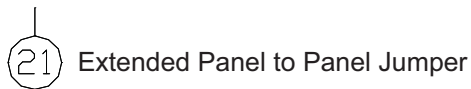
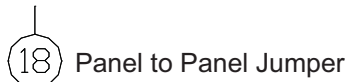
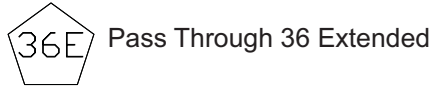
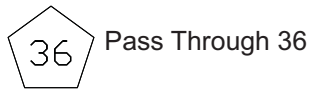
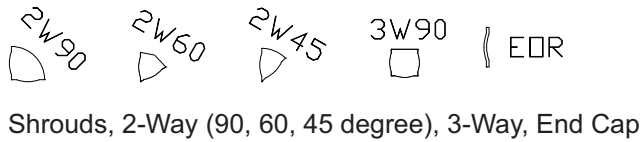
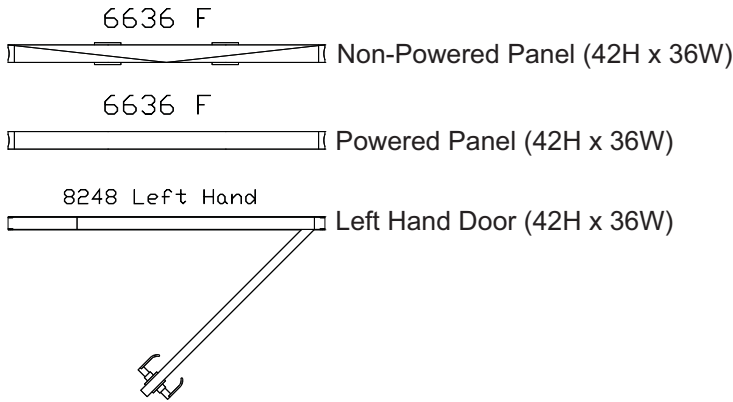

Individual Step Information

This installation guide contains step by step instructions. There are 4 points of interest for each step:

1. Step Number - Used to identify the specific step. This can also be useful if trying to reference a specific step when talking to an AIS field services member, or customer service when referencing parts.
2. Photo Image - Visual reference of the product explained within the step
3. Details - Verbage that explains the actions required within the step to proceed with the installation.
4. Technical Data - This is a "tips and tricks" comment, which may also contain commonly ordered part numbers for items such as screws, to assist in the installation. (NOTE: If the characters ## appear within a part number, these are to be replaced by dimension numbers) (NOTE 2: Some part numbers are adjusted slightly internally for individual sale, supplied numbers are for reference only)

1 → 001

2 →

3 → Identify Non-powered panels and separate from Powered panels. Non-powered panel shown at left.

4 → Non-Powered Panel. Please see catalog for complete panel listing.

Hinge Requirement Table

The below table will guide you to the specific hinge heights used in each different panel connection.

Note: This table is based on the lowest panel involved in the connection.

Note: The 20 7/8 hinge is the first one to use in all situations.

	Length and Number of Hinge Segments Required Per Panel Height			
	12 7/8	20 7/8	36 7/8	52 7/8
42" High	1	1		
50" High		2		
66" High		1	1	
82" High		1		1

001



Identify Non-powered panels and separate from Powered panels. Non-powered panel shown at left..

Non-Powered Panel. Please see catalog for complete panel listing.

- RP-HEMXGLD - Glide - Mwall 3/8"-16 X 1.5"
- P-VSATC ## - perm mono aluminum top cap ##" - painted
- P-VSTC ## - segmented top cap ##" - painted

002



Powered panel shown at left has powerway mounted at factory. Also separate panels by surface type, width and height.

Powered Panel. Please see catalog for complete panel listing.

- E-MW8W4 ## - Powerway - AIS 8 Wire 4 Circuit - ##"W
- E-MWMBM - Bracket - Mounting - 8W 4C

003



Polypropylene hinges are used to connect panels together.

Divi Hinge

004



Hinges are precut in the factory. Every panel ships with correct amount and sizes of hinges. Hinges are cut to 12 7/8, 20 7/8, 36 7/8, and 52 7/8. See Chart below for the appropriate sized hinges to use for each panel connection

Hinge - Last two numbers identify the length

RP-VSH __ (Fill in the correct length - 13, 21, 37, 53)

Note: See overview for hinge use guide for different panel heights

005



With panel glides turned to a matching height, align two panels as shown. Note that each panel has a pair of alignment plates that interlock when abutted, locking panels together vertically.

006



Panels interlocked prior to hinge installation.

007



Push panels together at the top. Level panels such that side rails remain parallel and flush. This will make hinge installation easier. Note hinge channels formed when panels are aligned.

008



Slide 20 7/8 inch long hinge down into hinge channels.

RP-VSH21 - 21" Hinge

009



Use non-marring mallet to tap hinge down fully.

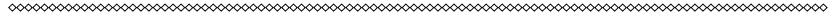

010



Use flat head screwdriver inserted into hinge channel at an angle to push first hinge down below top of side rail.

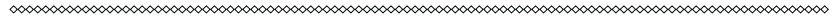

011

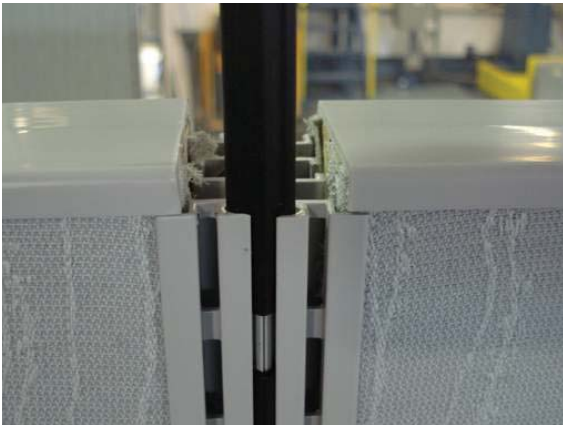

Insert second hinge and tap down both hinges with mallet.

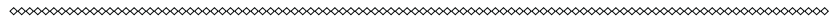

012



In certain situations on tall panels it may be necessary to tap first hinge down to bottom before tapping down second hinge.

Use flat head screwdriver inserted at angle into hinge channel and tap shaft of screwdriver gently to slide hinge down to bottom of panel.

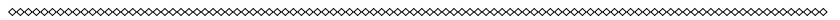

013



Important – Hinges must be fully engaged and seated directly on top of alignment plate at base of panel. No gaps can exist between plate and hinge.

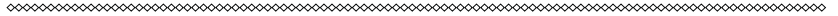

014

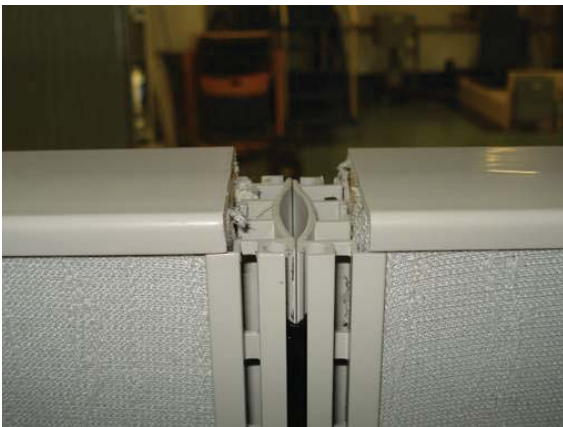

Important – Hinge must be recessed between 1/2 and 1/4 inches from top of side rail to leave space for hanger frame topcap. If panel connection is a 180 degree straight line condition, insert another complete set of hinges on opposite side of panels.

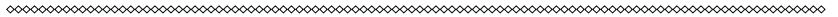

015



If connection condition is 45, 60 or 90 degrees, rotate panel appropriately into position.

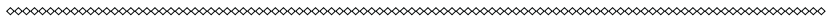

016



If creating a 3-way, install hinge when panels are at 180 deg and then swing one panel next to the other as shown.

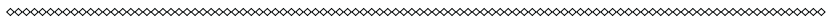

017



Interlock alignment tabs of third panel with tabs of second panel.

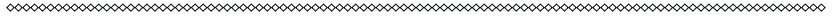

018



Interlock third panel to second panel.

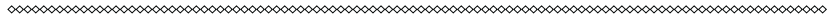

019



Slide first the 20 7/8 inch long hinge down into hinge channels and then the second hinge size based on panel height (see table).

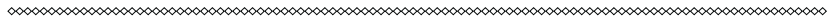

020



If creating a 3-way, 90 degree, swing panels into position.

If creating a 4-way, Swing third panel next to the other two as shown.

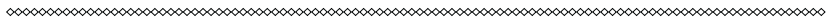

021



Interlock alignment tabs of fourth panel with tabs of third panel.

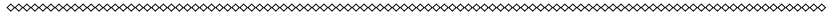

022



Interlock alignment tabs of fourth panel with tabs of third panel.

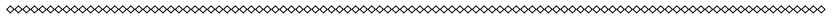

023



Slide first the 20 7/8 inch long hinge down into hinge channels and then the second hinge size based on panel height (see table)

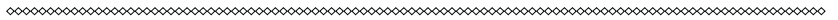

024



Swing third panel next to the fourth.

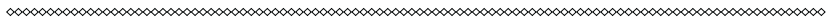

025



Swing third and fourth panels together until fourth touches first panel.

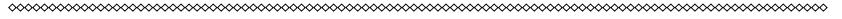

026



Slide first the 20 7/8 inch long hinge down into hinge channels and then the second hinge size based on panel height (see table).

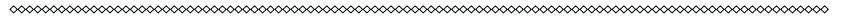

027



Rotate all panels 90 degrees until 4-way is at 90 degrees.

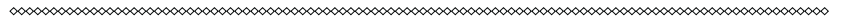

028



Rotate all panels 90 degrees until 4-way is at 90 degrees.

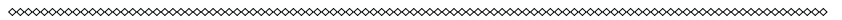

029



For HILO conditions, interlock alignment tabs of short panel with tabs of the tall.

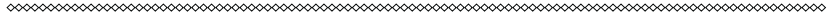

030



Slide the 20 7/8 inch long hinge down into hinge channel of the high panel.

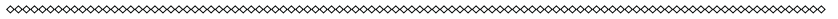

031



Slide the 20 7/8 inch long hinge down into hinge channel of the high panel down to the top of the low panel.

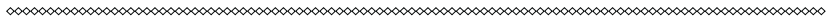

032



Repeat same process for second piece of hinge. Choose correct length using table at page 2 and the height of the short panel.

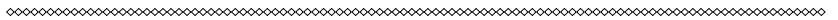

033



If creating a corner, rotate panel into position.

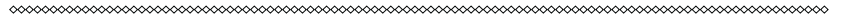

034

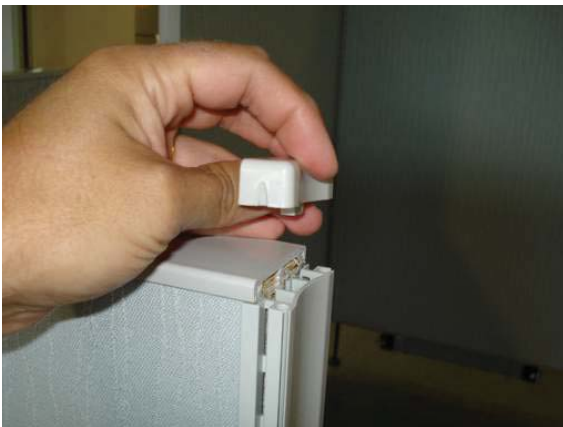

Hanger frame top caps must be installed to finish installation of panels.

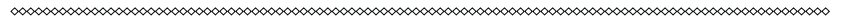

P-VSEC - End Cap Die Cast

035



Insert top cap into center channel of side rail and push down until flush.

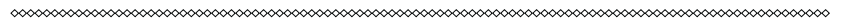

036



Finished 2-way connection. Note Hinge position allows for top caps to be seated properly.

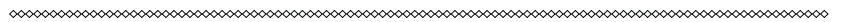

037



Finished Hilo connection. Note Hinge position allows for top caps to be seated properly.

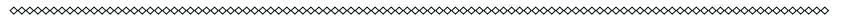

038



Finished 4-way connection. Note Hinge position allows for top caps to be seated properly.

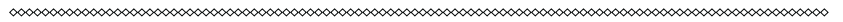

039

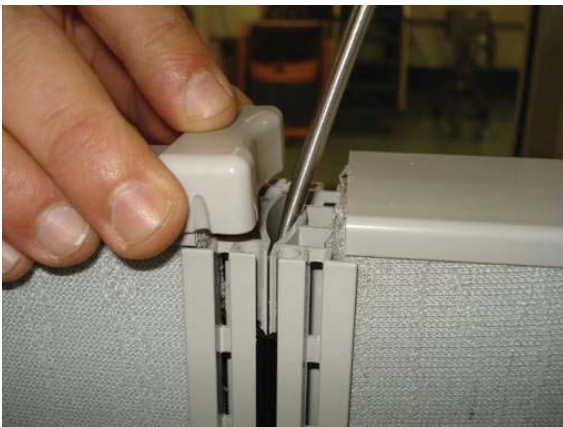

(old method, see #041-042 for new method)

At 180 degree connections, panels which are not perfectly level may bind at the top and prevent cap from installing. Leveling panels usually corrects this issue. However, in certain cases, it may be necessary to spread the panels with a screwdriver to make room for the top caps.

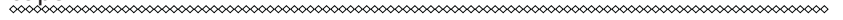

040

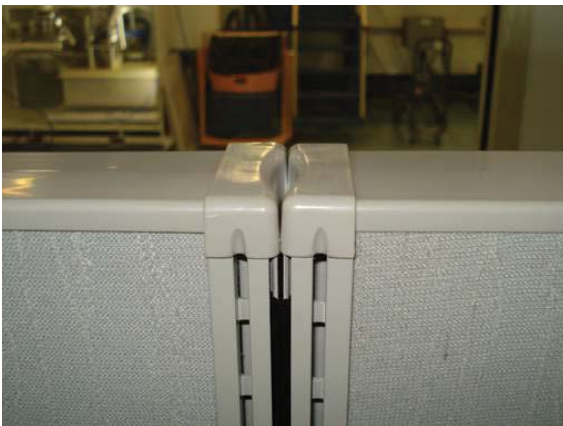

(old method, see #041-042 for new method)

Properly installed 180 degree connections.

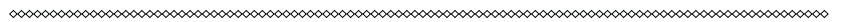

041

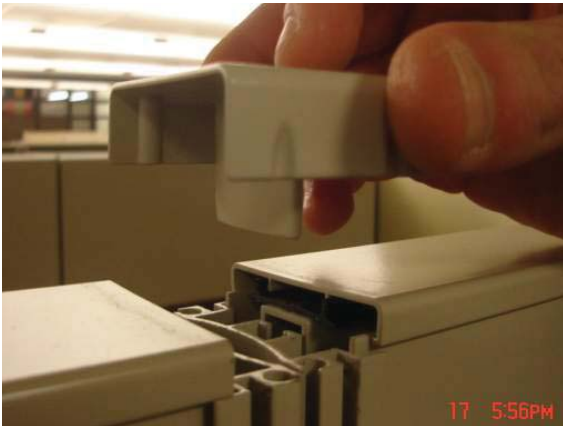

(new method as of March 2010)

As an aesthetic improvement, AIS has added in 180 degree hanger frame top caps. These insert between two panels, better closing in the hanger frame top caps, while providing a better line of sight to the top caps.

~~~~~  
P-VS180CM - 180 Degree Connector Cap Die Cast

042



(new method as of March 2010)

Properly installed 180 degree connection.

043



Outlets are marked circuits 1-4. The layout drawing will indicate which outlet goes where per the design. Note - in some locations, all electrical components must be installed by a licensed electrician. Install Duplex outlets by aligning the outlet interface with the power way interface as shown.

~~~~~  
E-MW8W4DO1 - Duplex Outlet Line 1 (Last number changes for lines 1, 2, 3 and 4)
RE-HM8W4S - Screw #8 32 x 1/2"
RE-HS1058F - Screw #10 24 x 5/8 Type F for Outlets Only

044



Slide outlet to the left on the left side, or to the right on the right side, until fully engaged on powerway as shown. Outlet cannot be installed upside-down. Using screws provided for "Outlets", screw outlet to powerway as shown. Only one screw, top or bottom, is required. NOTE – Outlets MUST be screwed to powerways.

045



Install Jumpers as indicated WITH ARROWS on JUMPER modular end pointing UP as shown. Engage jumper fully onto powerway in one of the 2 end locations. Safety Clip MUST BE fully engaged over Clip Ramp to be fully installed.

046

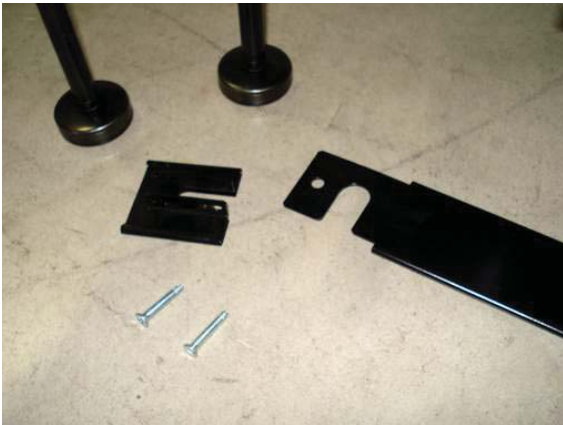

Metal Raceway dividers are available should a client desire High voltage and low voltage to be separated by a metal barrier.

RP-VSD## - Data Septum##" (Small Piece, 2 per panel if ordered)
RP-VSDL - Sata Septum Lock (Large Piece, 1 per panel if ordered)

047



Hold metal divide over glide housings as shown and slide clamp over end to trap divider and glide housing.

048



Using screws provided, "close" clamp to grip glide housing as shown. Make sure metal barrier is sitting flush with underside of powerway.

RP-SAHPS - Screw #8 x 3/4" flat phil machine self-thread

049



Connecting bridges for 2-ways and 3-ways of all angles, as well a 4-way 90 degrees, are used to make the metal barrier continuous throughout the entire system.

.....
 The small bridge piece comes in a few different versions

- RP-VSD180 - Data Septum 180 Degree
- RP-VSD90 - Data Septum 90 Degree (shown)
- RP-VSDS3W90 - Data Septum 3-way 90 Degree
- RP-VSDS45 - Data Septum 45 Degree
- RP-VSDS60D - Data Septum 60 Degree

050



Connecting bridges simply "lay" on top of the adjacent barriers.

051



Base covers are shipped separately from panels and are installed after panel installation.

.....
 There are versions of the raceway with and without knock outs
 Each of these part numbers would end in a dimension and color

- RP-VSKPCN ## __ - Powered Raceway Cover
- RP-VSKREB ## __ - Non-Powered Raceway Cover

052

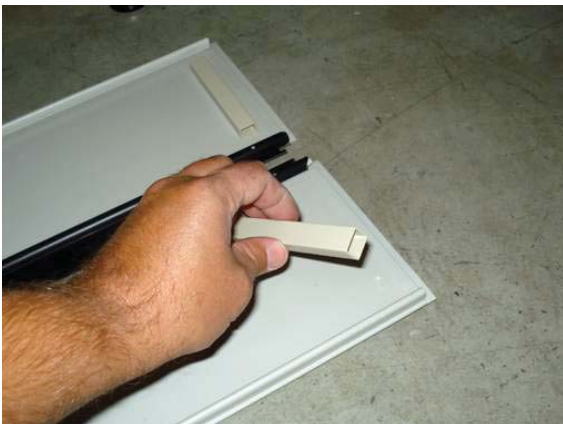

Remove shipping "tubes" from base covers before installation.
 These tubes may be discarded. They are used to prevent base cover assemblies from bowing in transit.

053



Slide one end of base covers under leveled panels.

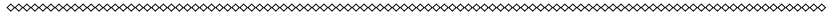

054



Slide other end of base covers. Do not close base covers at this point. Raceway shrouds must be installed before base covers are closed.

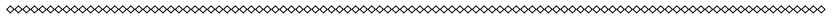

055



IMPORTANT – DO NOT CLOSE BASE COVERS UNTIL AFTER SHROUDS ARE INSTALLED.

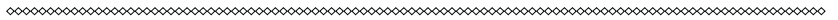

056



Raceway end caps finish the end of a panel run.

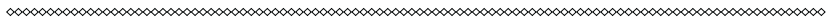

057



Snap nubs on bottom of shrouds into "key slots" on bottom of raceway assembly. BE SURE BOTH NUBS ARE SECURED.

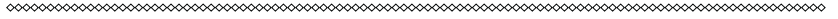

058



Snap top prongs into the holes located on underside of alignment plates.

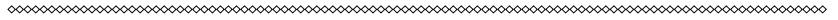

059



Properly installed raceway end cap.

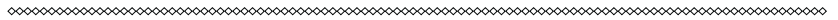

060

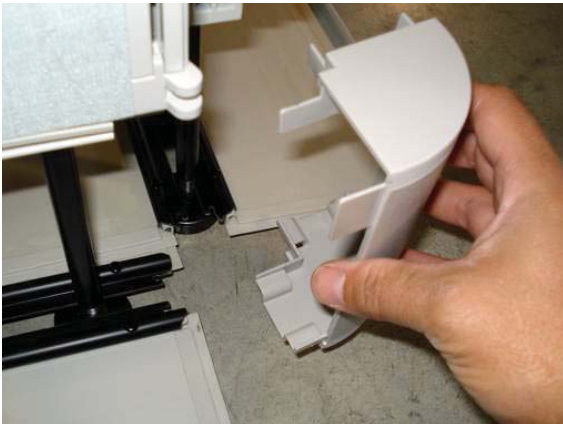

Snap nubs on bottom of shrouds into "key slots" on bottom of raceway assembly. BE SURE BOTH sets of NUBS ARE SECURED.

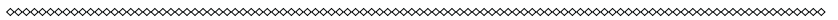

061



Properly installed 2-way 90 degree shroud. NOTE – 2-way 45 degree and 2-way 60 degree connections require different shrouds.

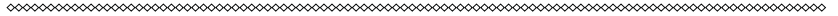

062

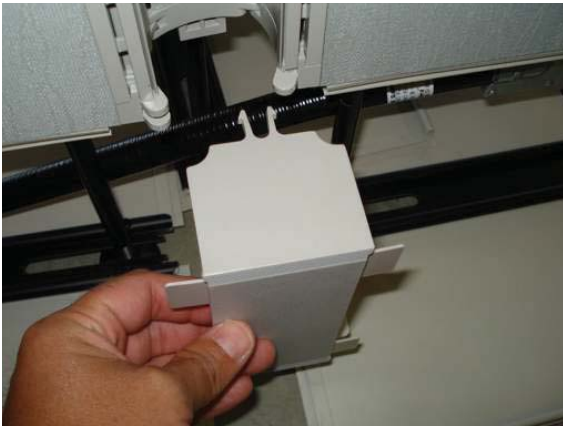

Snap nubs on bottom of the 3-way shroud into key slots on bottom of the MIDDLE raceway assembly. Snap top prongs into the holes on underside of the middle alignment plate.

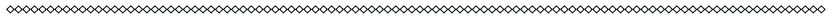

063



To properly close base covers, raceway assembly must be centered laterally on panel. Align seam between mud flap and hard plastic of base cover with the RIGHT EDGE of hanger frame slot. With base cover centered on panel, insert lip on base cover into groove on underside of panel and firmly push to close base cover.

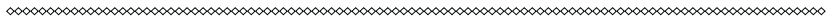

064

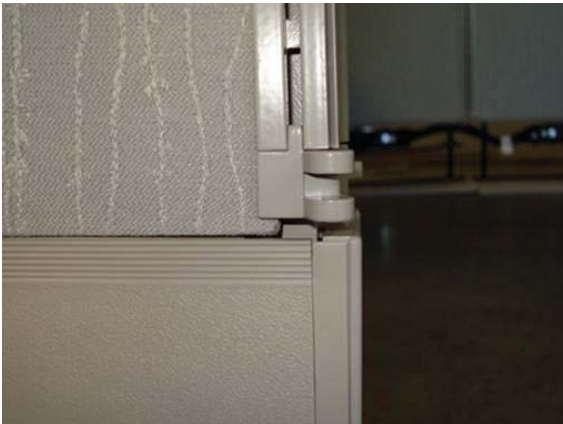

IMPORTANT – MAKE SURE BASES COVERS ARE PROPERLY CENTERED ON PANEL AS SHOWN.

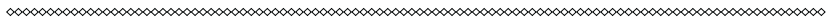

065



Mud flaps of base covers when are closed must overlap 90 degree shroud.
IMPORTANT – MAKE SURE BASES COVERS ARE PROPERLY CENTERED ON PANEL AS SHOWN. SHROUD SITS INSIDE RACEWAY COVERS.

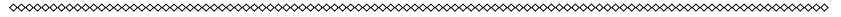

066



Mud flaps of base covers overlap 3-Way shroud.
IMPORTANT – MAKE SURE BASES COVERS ARE PROPERLY CENTERED ON PANEL AS SHOWN. SHROUD SITS INSIDE RACEWAY COVERS.

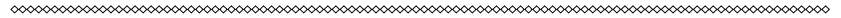

067



Base covers for powered panels have 2 sets of holes. Top holes are for electrical, bottom holes are for data jack housings.

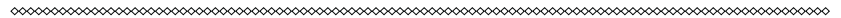

068



6 Port Data Jack housing, Cat 3 and Cat 6 data jacks and hole blanks are ordered separately.



069



When assembled and data jacks are terminated, housing snaps into raceway covers as shown.

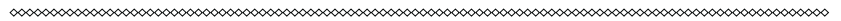

070



Properly installed base covers and shrouds.

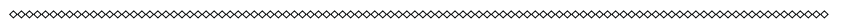

071

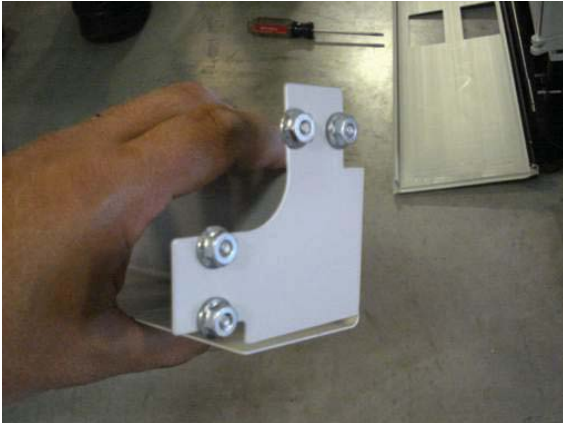

Inline Power / Data Pole

Install #8-32 hex nuts on the bottom studs of the 2-way power pole shroud. Do not fully tighten nuts. Leave a gap about 1/16".

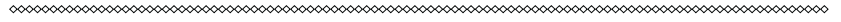

Replacement metal Shrouds for Inline Poles / 3 configurations

- RP-VSPPIL2 - Pole / Post Filler 2 Way Shroud
- RP-VSPPIL3 - Pole / Post Filler 3 Way Shroud
- RP-VSEORS - Pole . Post Filler End of Run Shroud

RH-HNZM632 - Nut - #6-32 zinc nut

072



Insert studs of the shroud into the raceway key slots. Tighten the nuts.

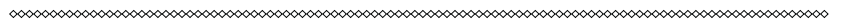

073



Place post filler into the 90 degree corner on top of the base shroud.

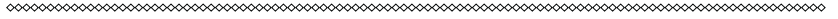

074

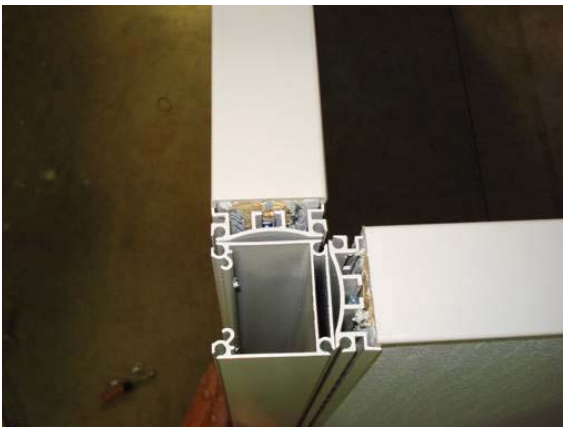

Note, pole is 3 sided. When using as a aesthetic "filler", turn 3rd side towards inside. Note that all sides of pole have "hinge channels" for installation to panels. Install hinges on both sides of the post filler.

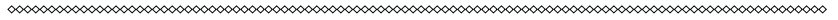

075



Slide first the 20 7/8 inch long hinge down into hinge channels and then the second hinge size based on panel height (see table).

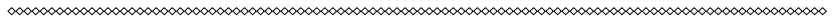

076

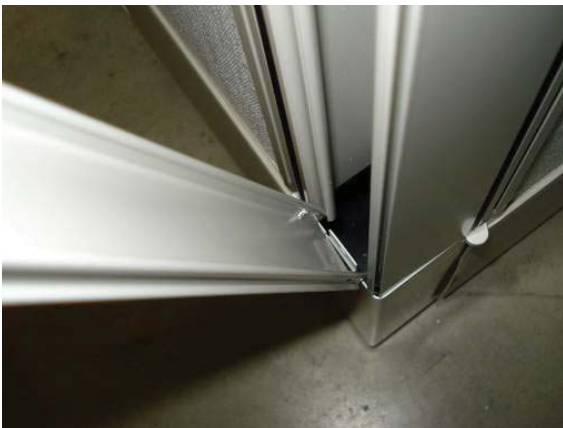

Line bottom edge of post filler cover with bottom section of post filler body. Snap the cover in place on the power pole.

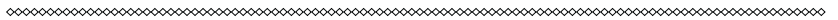

077



Line bottom edge of post filler cover with bottom section of post filler body. Snap the cover in place on the power pole.

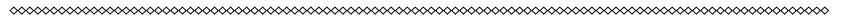

078

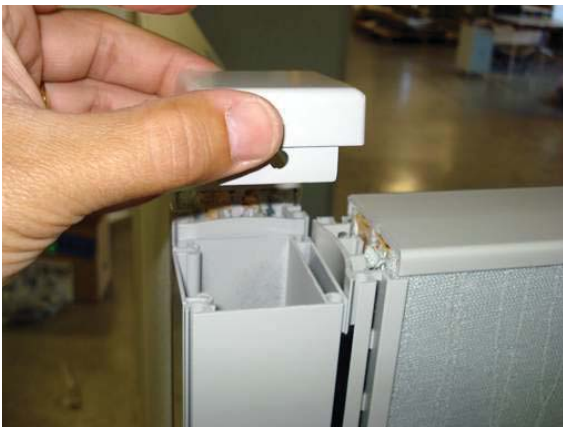

Install post filler top cap by inserting down into post filler.

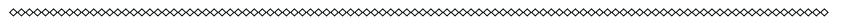

RP-VSPPI LTC - Post Filler Top Cap

079



Post filler top cap must be flush with the hanger frame top caps.

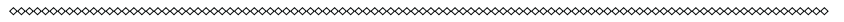

Note: If using an Inline Power Pole, there MUST be a post filler installed in order to support the pole.

080



Install the 4 locking screws in the Pole Coupler.

IMPORTANT- Make sure screws do not protrude past back surface of the coupler at this time.

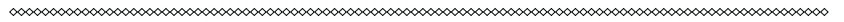

RA-VSPPCP - In-Line Pole Coupler

RP-MXHS83214 - AIS Screw 8-32 x 5/16"

081



Slide the bottom half of the Pole Coupler into the power pole on the panels. Keep the coupler as centered on the top of the power pole as possible.

Tighten the bottom screws to hold the coupler in place.

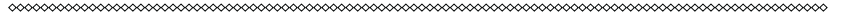

082



Slide the upper section of the power pole over the assembled lower section & Pole Coupler.

Tighten the screws to lock the upper section of the power pole in place.

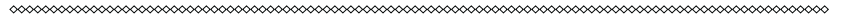

083



Line up the lower edge of the upper power pole cover with the top edge of the lower cover.

Place on edge in the power pole and rotate the cover into position, snapping it in place.

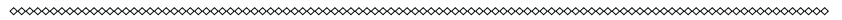

084



Make sure all seams are as even as possible on the completed power pole.

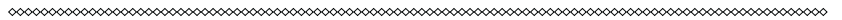

RA-VSPPCS - In-Line Pole Ceiling Shroud

085



The pole comes in two sections. Either section can be used for top or bottom.

Make sure the opening of the lower section is at the bottom of the power pole when installed.

RA-PPSUN - Power Pole Shell

086



Note pole has multiple sets of rectangular punch-out's. Knockout bottom set as shown. DO NOT KNOCK OUT PUNCHOUTS ON THE SECOND SECTION OF POLE THAT WILL BE USED FOR THE TOP.

087



Knocked out holes for bottom section.

088



Knock out top set of punches only if installing on a 66 high panel.
Knock out second set down only if installing on a 50 high panel.
Knockout 3rd set down only if installing on a 42 high panel.

089



Install power pole retaining bracket by inserting into the hanger frame slot and engaging DOWN. Note that teeth are universal and bracket is non-handed.

RA-PPBDV - Power Pole Bracket

090



Install 1 bracket facing in on left such that the threaded stud on the bracket is at the same height as the uppermost set of punches on the lower power pole section.

091



Install 1 bracket facing in on right such that the threaded stud on the bracket is at the same height as the uppermost set of punches on the lower power pole section.

092



Hang pole on threaded studs as shown.

093

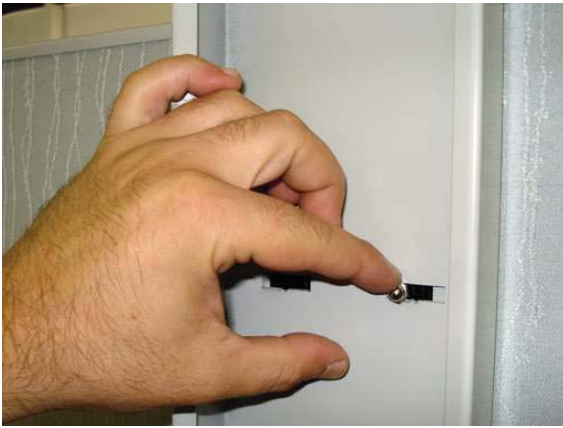

Using acorn nuts supplied, cap threaded studs but DO NOT TIGHTEN ALL THE WAY.

RA-KEYBN - Nut - #8-32 acorn nut

094



Hang brackets at bottom as show temporarily swinging pole out of the way.

095



IMPORTANT– bottom brackets are designed to engage hanger frame moving upwards, thus locking pole onto panel. With a screw driver, LIFT bottom brackets up while aligning bottom set of punch-out's. Push pole in to trap bracket studs and prevent the brackets from falling. Cap loosely with acorn nuts.

096



PLUMB and level pole and then tighten nuts.

097



Install the 4 locking screws in the Double Channel Pole Coupler.

IMPORTANT- Make sure screws do not protrude past back surface of the coupler at this time.

RA-PPCP - Power Pole Coupler

RP-MXHS83214 - AIS Screw 8-32 x 5/16"

098



Slide the bottom half of the Pole Coupler into the power pole on the panels. Keep the coupler as centered on the top of the power pole as possible.

Tighten the bottom screws to hold the coupler in place.

099



Slide the upper section of the power pole over the assembled lower section & Pole Coupler.

Tighten the screws to lock the upper section of the power pole in place.

100



Install dividers as needed with acorn nuts.

RA-PPDUN - Power Pole Divider

101



Line bottom edge of pole cover with bottom section of pole. Snap the cover in place on the power pole.

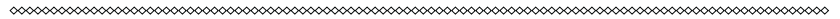

RA-PPCV - Power Pole Cover

102



Line bottom edge of pole cover with top section of post filler body. Snap the cover in place on the power pole.

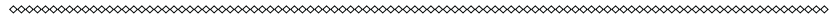

103



Properly installed pole covers.

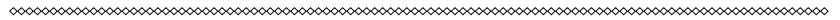

104

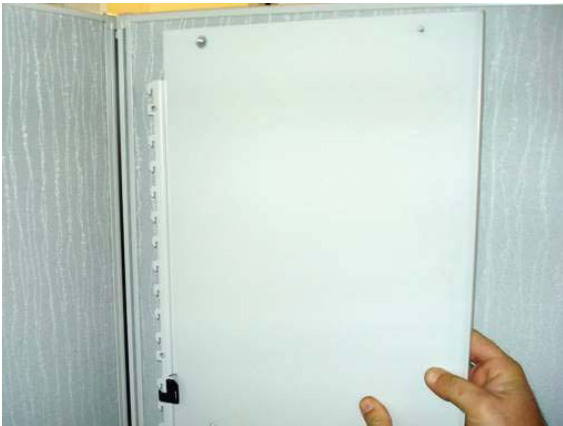

Insert right hand shelf end into right hand hanger frame slightly below the level of a panel top cap.

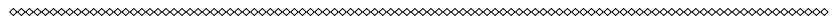

RS-SHFEFDVL - shelf end - full height - metal - left
RS-SHFEFDVR - shelf end - full height - metal - right

105



Insert shelf end into frame and down until firmly seated on hanger frame. Anti-dislodge Cam should rotate back as shelf end is inserted.

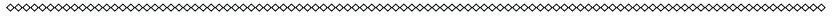

106



Once end is firmly seated on frame, rotate cam into hanger frame so back edge of cam is parallel to panel face.

To remove shelf end, rotate cam back out and lift end. Repeat this procedure for left ends and Mid Height Shelf Ends.

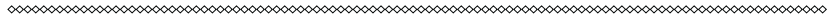

107



Hold shelf pan between shelf ends and lower over nuts on shelf end. This may require turning nuts out to loosen slightly. BE CAREFUL NOT TO SCRATCH paint on shelf ends as you insert and lower shelf.

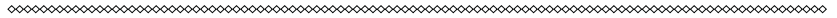

RS-SHF ## ME - Shelf - metal ##"w 23 3/4" for metal end overheads
RS-HNZFS832B -Nut zinc plated serrated flange #8-32(hnzfs832)

108



Shelf pan has two slot patterns on end. Use slot pattern as show to properly position shelf. Tighten nuts on shelf studs.



109



Lock slot should be positioned at front on bottom shelf pan.

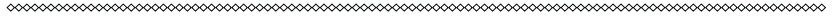

110



Install top shelf pan in the same way, with the hole pattern for mounting a flipper door at the front as shown.

NOTE - Top shelf and bottom shelf ARE THE SAME PART mounted in opposite directions.

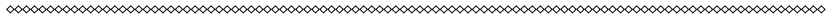

111



Rest flipper door face assembly on top shelf with gear track hinges oriented as shown.

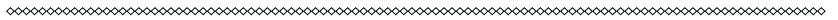

112



Align holes on gear track hinges with holes on front of shelf pan and attach with screws provided labeled "Flipper Doors".

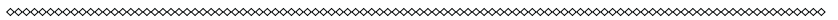

RP-MXHS83214 - AIS Screw 8-32 x 5/16"

113



Mid height shelves install in the same manner as flipper door units. BE SURE TO TEST LOCK ON FLIPPER DOOR UNIT.

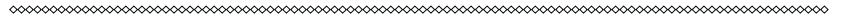

114



Task light brackets must be assembled to task lights prior to installation.

Slide bracket through slots on each end of light.

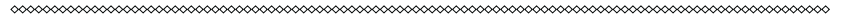

115

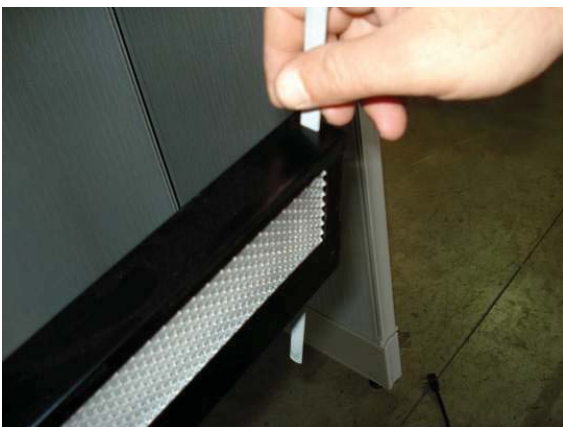

The bracket must extend through the back slot on the light as well. Center the bracket on the light.

Repeat with second bracket on other end of light.

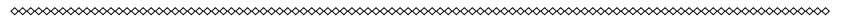

116



Hold light up under shelf pan. Place back of brackets on rear shelf lip. Bend front brackets to fit under front shelf lip.

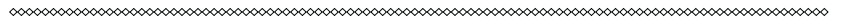

117



Center light left to right on shelf. Be sure each end of the brackets is firmly seated. Failure to do so could result in injury.

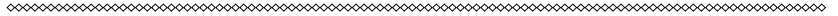

118



Counter top brackets teeth insert UP into hanger frame. Insert hook tooth at bottom of bracket into hanger frame at appropriate height and rotate bracket up into a vertical position.



119



Locate hanger frame slot positioned to line bracket up just below the top of the panel. Please the long tooth in that slot, then rotate the bracket into position.

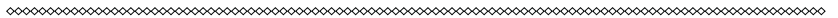

120



Mount top of bracket flush with top of top cap. Bracket will need to be lightly tapped to engage upwards fully and to prevent bracket from falling before installing top.

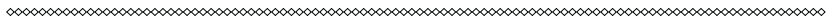

121



Countertop brackets are handed. Each countertop requires at least two pairs of brackets.

WPS-CTBLDV - Counter Top Bracket - Left
WPS-CTBRDV - Counter Top Bracket - Right

RS-HS09W - Screw #9-1"L Flat Head (Attach Object to Worksurface)

122



Align countertop on center of panel. With screws provided labeled for "Work surfaces", attach bracket to work surface. Use at least 2 screws per bracket.

123



Secure 1 screw on each side of panel first to stabilize top, then complete attachment with remaining holes, alternating from one side of panel to the next.

124



Shared cantilevers are used to support panel hung work surfaces at a seam between two panels. Cantilevers are inserted into the hanger frame slot down at an angle matching the teeth.

125



Push down on cantilever and make sure cantilever is fully engaged.
NOTE – failure to engage cantilever properly can lead to injury.
Cantilevers should be hung between 27 3/4 and 29 inches to achieve industry standard work surface height and match structural pedestal heights.

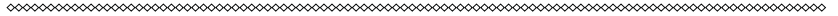

126



Side support rear brackets provide direct support for work surfaces at the rear of corner work surfaces or along work surface sides.

Insert hook tooth at top of bracket into hanger frame...



127



Rotate bracket down into hanger frame and engage down 1/4 inch.

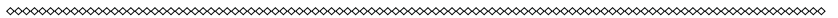

128



Be sure bracket is fully engage on hanger frame. Failure to properly engage bracket could result in injury.

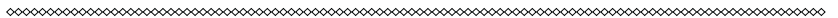

129



Double check heights of all support elements to ensure that work surfaces will be level. Check under desk pedestals as well.

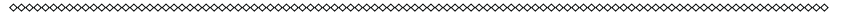

130



Rest work surfaces on top of work surface supports such that edges are 1/4 inch from panel face and that corners are aligned on the center of panel corners...

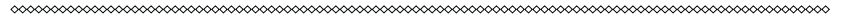

131

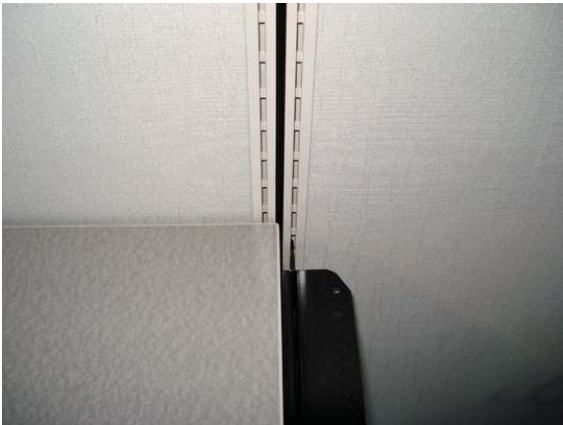

Work surface should "touch" at seams and seams should be aligned with panel seams.

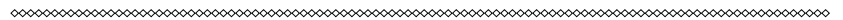

132



While holding work surfaces in place and maintaining alignment, screw work surfaces to cantilevers with screws provided labeled "For Work surfaces". Use 2 screws for regular cantilevers and 4 screws for shared cantilevers.

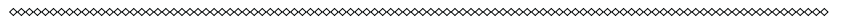

RS-HS09W - Screw #9-1"L Flat Head (Attach Object to Worksurface)

133



Install flat plates at seams between work surfaces in front of shared cantilevers.

RS-HS09W - Screw #9-1"L Flat Head (Attach Object to Worksurface)

134



Align pedestal flush with front of work surface and screw to work surface with screws labeled "For work surfaces". Use at least 2 screws at the front of pedestal. For best results, use screws at all 4 corners of pedestal.

135



To replace drawers, push all ball bearing slides into pedestal BUT KEEP INNER BALL BEARING CARRIAGE pulled forward to front of slide. Carefully align track on drawer boxes with inner slide carriage and slowly insert drawer...

136



Push drawer in to face, then open fully and close to ensure proper slide alignment. IT IS NOT NECESSARY to actuate levers on drawer stops while reinserting drawers. NOTE - BE SURE TO TEST LOCK ON PEDESTALS AND adjust as needed.

137



Install tack boards by aligning tack board brackets with hanger frame slots approximate 1 inch above work surfaces. Be sure task light cord is behind tack board.

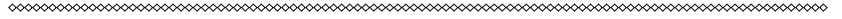

138



Insert tack board in and down. Be sure each side if firmly seated in hanger frame.

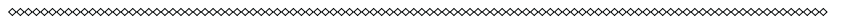
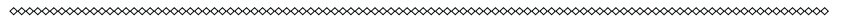
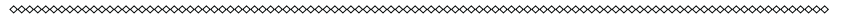

145

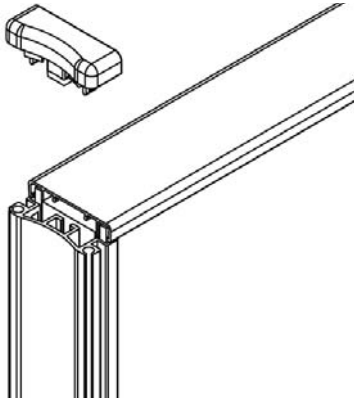

Remove Hanger Frame Topcap by depressing tabs inside top slot of hanger frame and lifting up.



146

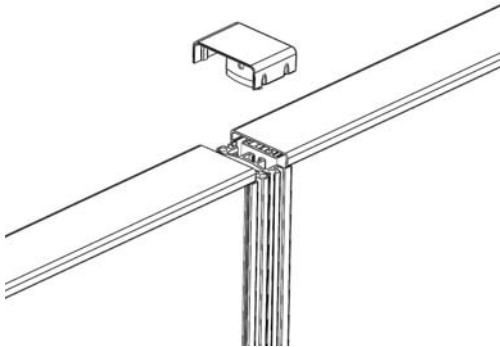

180 Hanger Frame Top Caps also exist
(Product Addition February of 2010, for post-hinge installation)

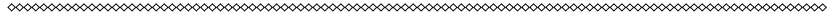

147

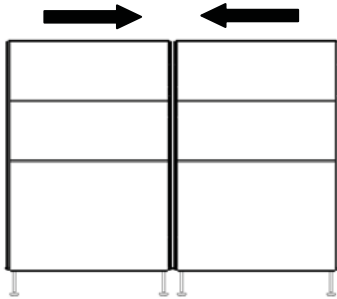

Hold panel flush and in a STRAIGHT LINE (180 degrees to each other). If possible, start at a 2-way connection closest to highest point on floor to make leveling panels easier as you build.

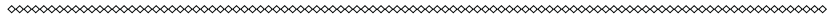

148

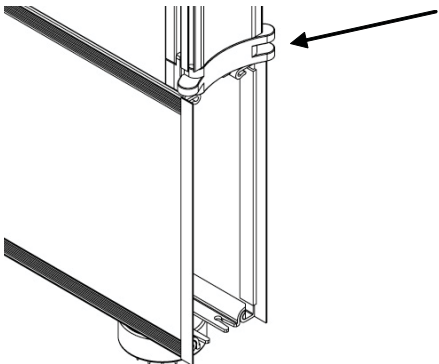

Make sure Vertical Alignment Tabs at bottom of Hanger Rail are horizontally aligned (level) with each other. If not (Fig A149) adjust glide(s) on panels to raise or lower panels so tabs are aligned. (Fig B150)

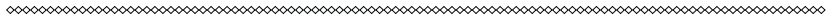

149

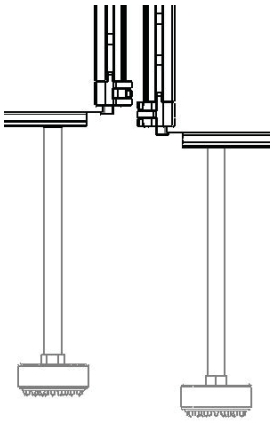
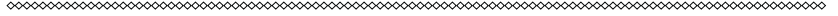

Fig A



150

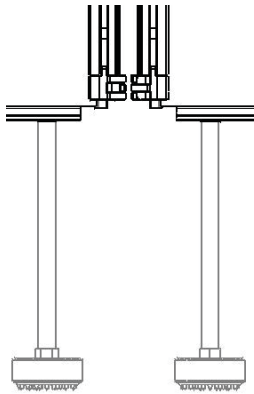
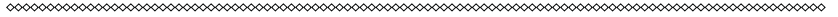
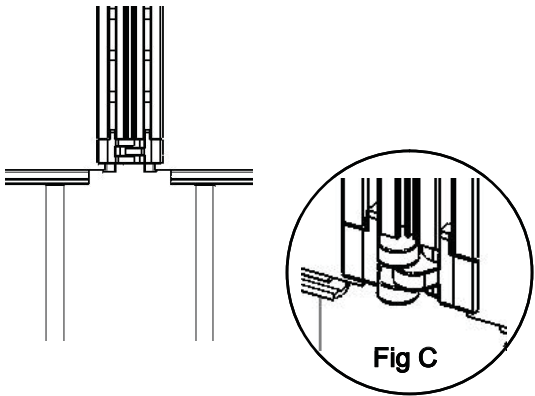

Fig B



151



With Alignment Tabs level, move panels towards each other to interlock Alignment Tabs as shown in Figure C. Hanger Rail edges should ALMOST touch.

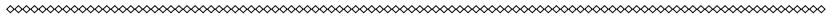

152

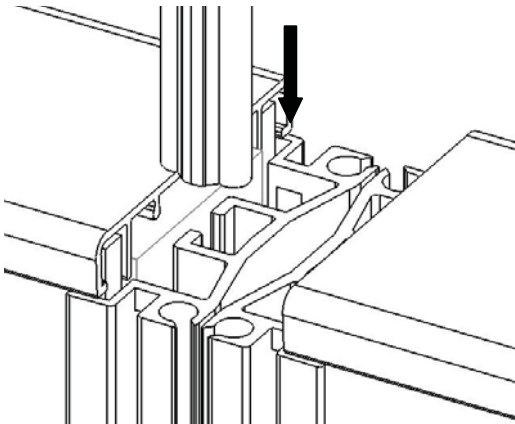

Each Hinge Is Cut Into Two Parts, A Smaller And A Larger. See Chart Below For What Combinations Apply To What Panel Heights. Insert Smaller Of 2 Hinges Into Hanger Rail Hinge Channels And Slide Carefully Down....

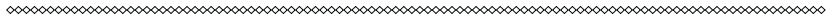

153

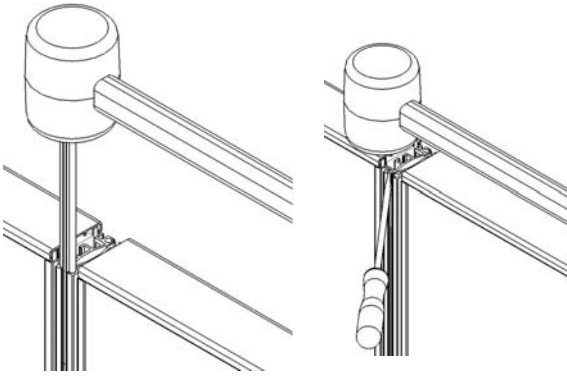

A "non-marring" mallet may be used to tap first hinge down until flush with hanger rail top. At that point, the 1st hinge can be TAPPED DOWN TO BOTTOM of panel by using a screwdriver and inserting the tip of screwdriver as shown in Fig D154 and tapping shaft of screw driver until first hinge is all the way down. DO NOT use screw driver AS SHOWN IN FIG E155, as this could damage hinge. Repeat with second hinge to complete hinge installation.

154

Fig D - CORRECT

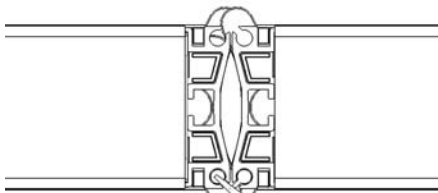

Screwdriver tip in channel = Correct

Fig D - Correct

155

Fig E - INCORRECT/WRONG

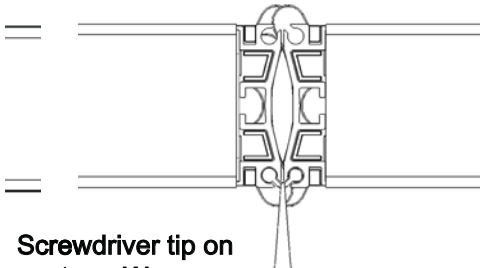

Screwdriver tip on center = Wrong

Fig E - Incorrect

156

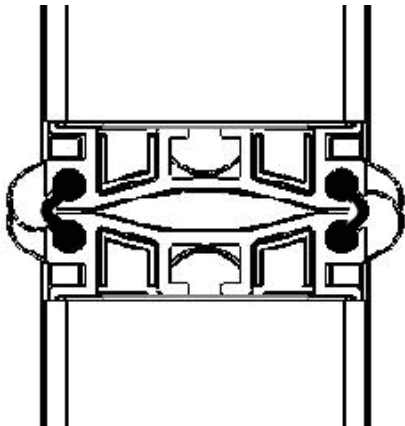

Straight Line (180 degree) Install 2 Hinge Combos

157

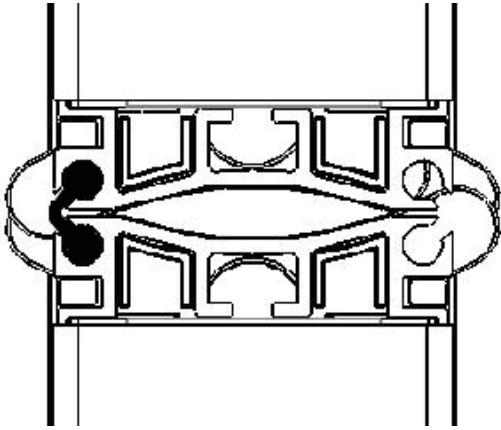

2-Way 90 or 60 or 45 DEG – Install 1 Hinge Combo, then rotate panels to appropriate angle.

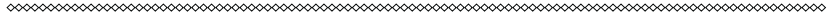

158

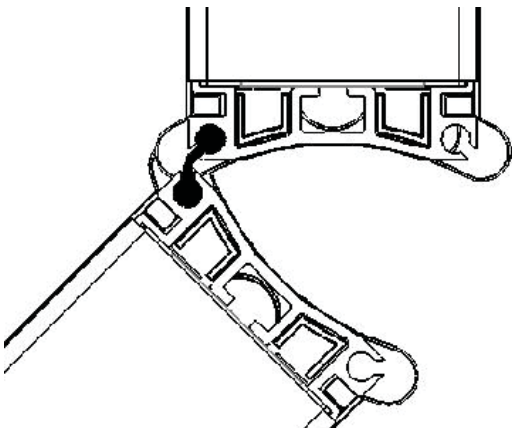

Rotate for 2-Way 45/135 Deg

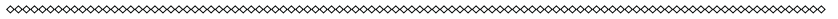

159

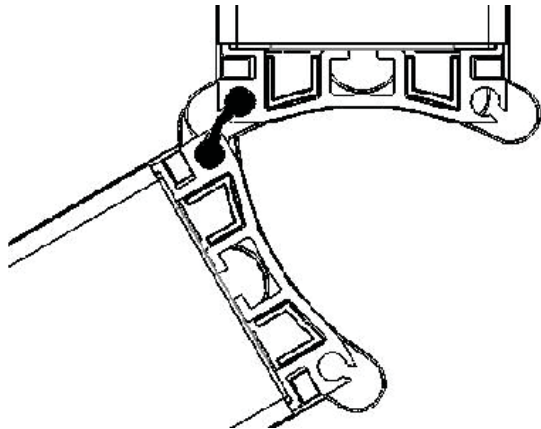

Rotate for 2-Way 60/120 Deg

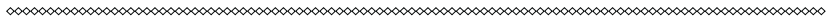

160

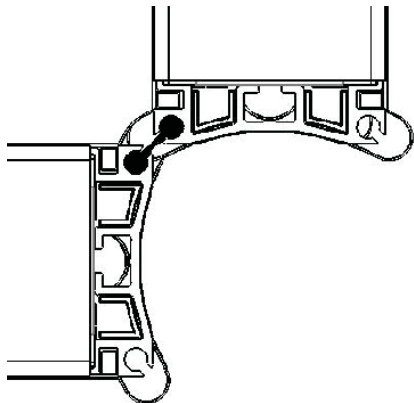

2-Way 90 Deg

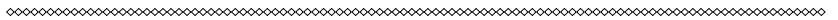

161

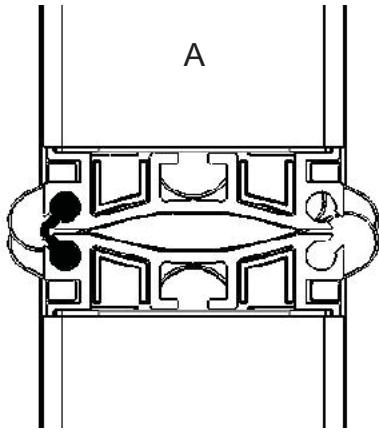

3-Way 90 DEGREE – (1) Install 1 Hinge Combo between panel A and B. (2) Rotate Panel B approx 180 degrees as shown. (3) Interlock Panel C Alignment Tabs with Panel B and install 1 Hinge Combo between Panel B and C. (4) Rotate Panel B and C as shown into appropriate 3-way 90 degree.
 For 120 Degree, simply close the 3-way and add hinges to the close point.

162

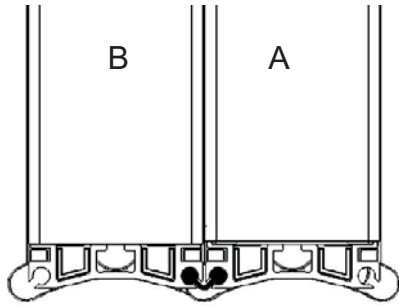

163

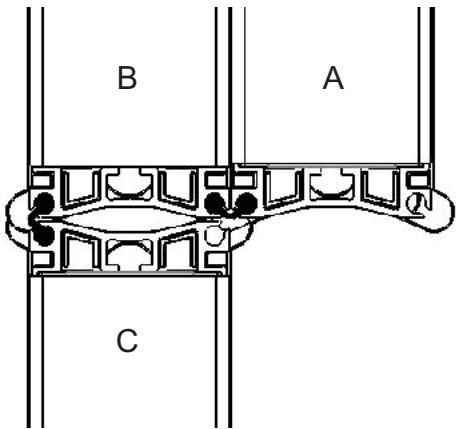

164

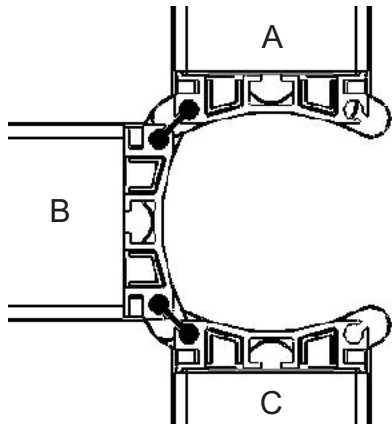

165

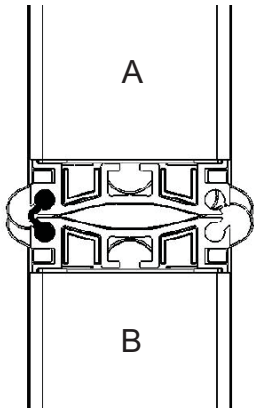

4-Way 90 DEG – (1) Install 1 Hinge Combo between panel A and B.

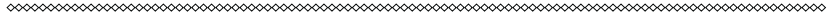

166

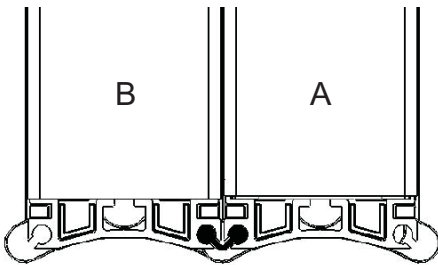

4-Way 90 DEG – (2) Rotate Panel B approx 180 degrees as shown.

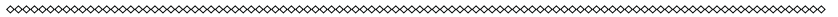

167

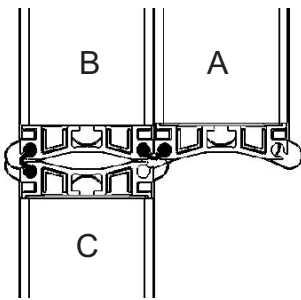

4-Way 90 DEG – (3) Interlock Panel C Alignment Tabs with Panel B and install 1 Hinge Combo between Panel B and C.

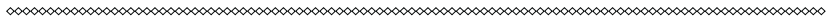

168

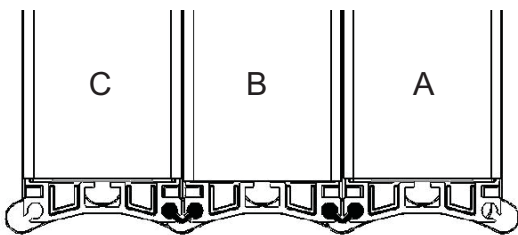

4-Way 90 DEG – (4) Rotate Panel C approx 180 degrees as shown.

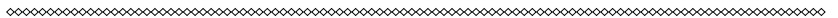

169

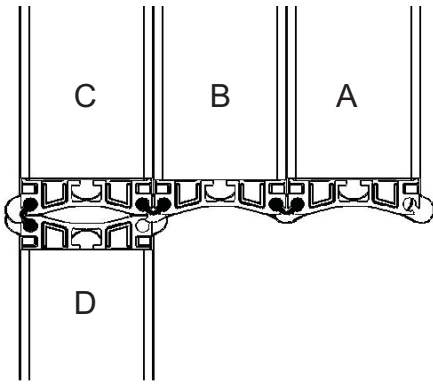

4-Way 90 DEG – (5) Interlock Panel D Alignment Tabs with Panel C and install 1 Hinge Combo between Panel C and D.

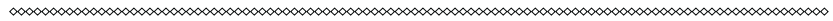

170

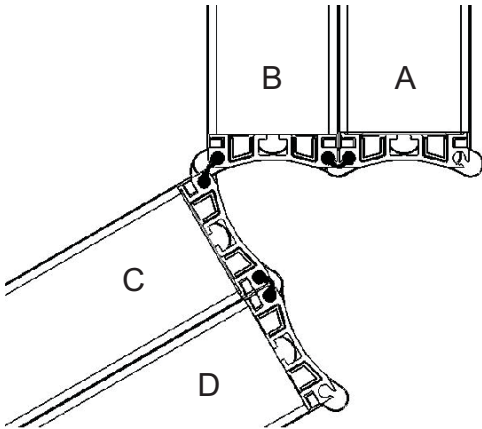

4-Way 90 DEG – (6) Rotate both C and D back 180 degrees as shown

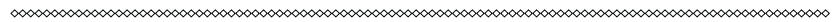

171

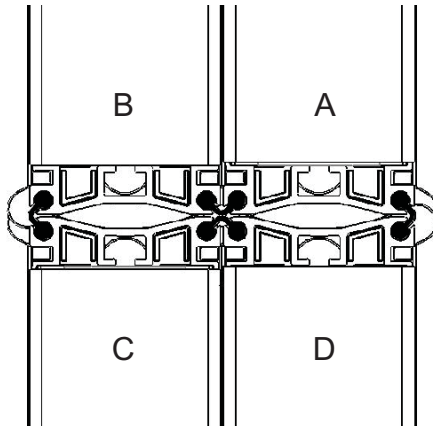

4-Way 90 DEG – (7) install final hinge combo between Panel D and A.

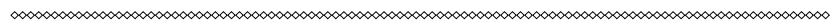

172

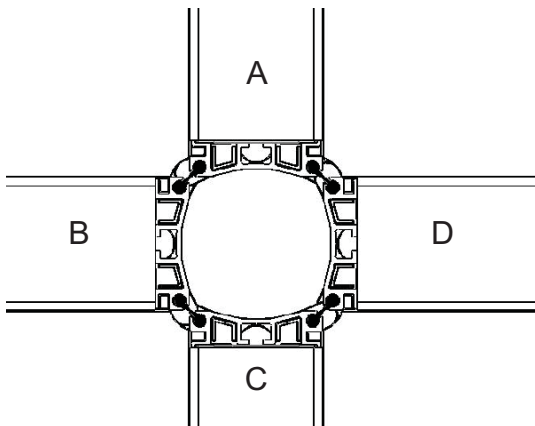

4-Way 90 DEG – (8) Rotate all panels 90 degrees until 4-way is at 90 degrees.

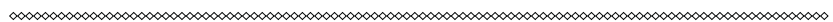

Details

DiVi stack-on panels are held in place with four pins using the same channel in the panel hanger frame that the hinges use. Stack-on installation is virtually the same for both permanent monolithic and insert panels, with the exception of insert panels requiring an additional step for the insert retainers.

Permanent Monolithic Glass Stack Installation

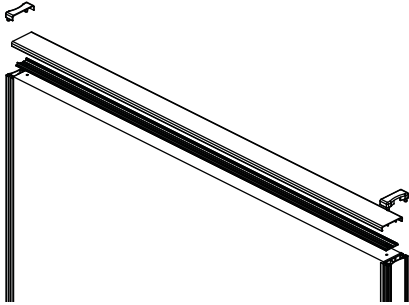

Step 1: Remove hanger rail end topcaps, panel topcap, and topcap retainer.
 NOTE: Remove topcap carefully as it will be installed on top of the stack-on.

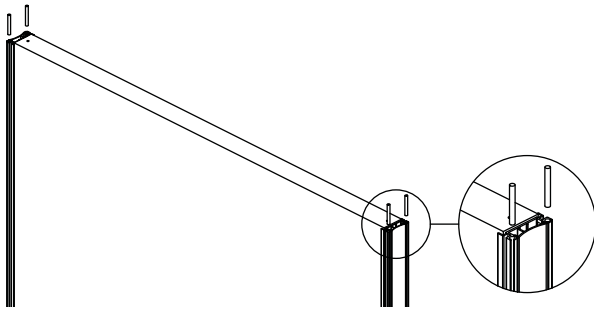

Step 2: Insert four pins into the hinge channels of the hanger frame. **IMPORTANT** - See warning note (right). Pins need to be 3/4" into the channel (use a mallet for this step). (Pin Part Number RH-RP316112)

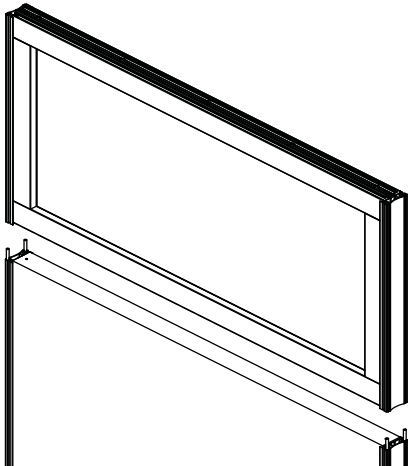

Step 3: Install stack-on using the pins to secure the unit. Use a mallet and slowly tap the stack-on panel into place. **DO NOT hit the topcap retainer with mallet.**

Finish: Reinstall the topcap and hanger rail end topcaps.

Insert Panel Stack Installation

Step 1: Complete Steps 1-3 (left) without re-installing topcap.

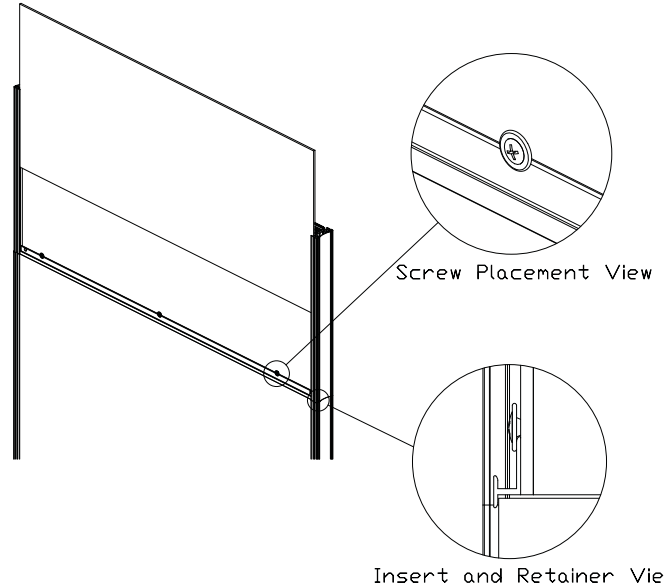

Step 2: Slide insert retainer into place, then secure the retainer with the provided screws.
 Step 3: Slide insert into the stack-on panel.
 Step 4: Reinstall the topcap and hanger rail topcaps.



In order to properly seat the four pins into the existing panel, you will need to pull up the existing panel hinges and cut a small piece out of one side. The cut out should be 1.5" (see below right).

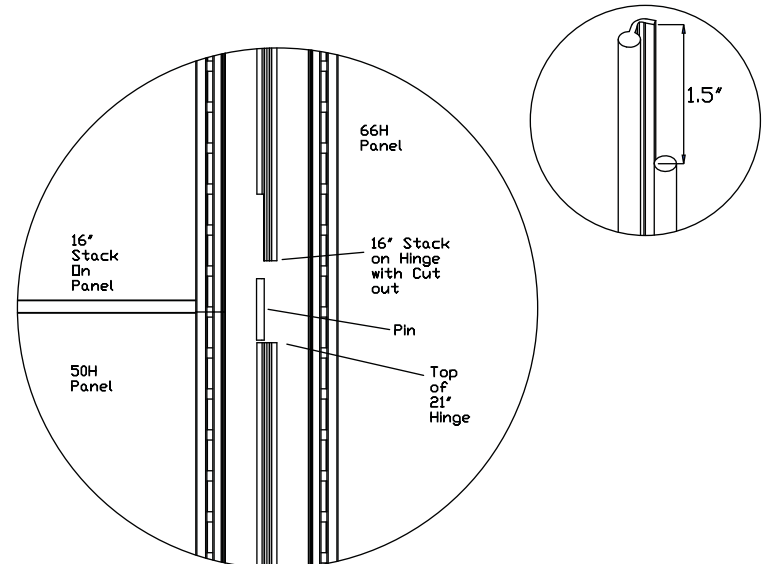

HiLo Situation

173

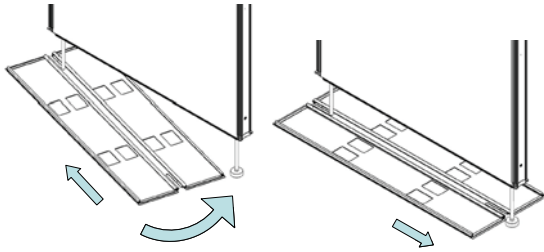

Stage Base Covers – Slide base covers under leveled panels as shown at right and leave open. Do not close base covers at this point. Raceway shrouds must be installed before base covers are closed

174

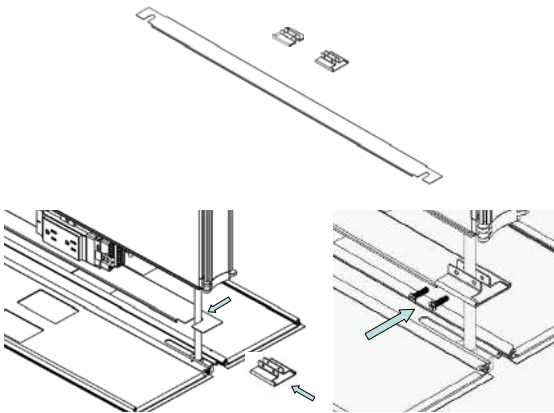

Install Panel Septum's - Slide septum into equal length panel over glide stems 3 1/8 inches down from raceway cavity top EDGE. Slide Septum Lock over end of septum around glide and tighten down with 2 screws as shown. Screws should be tight to prevent septum from sliding down.

NOTE: Pane Septums (Dividers) are optional and may not be included in most installations.

175

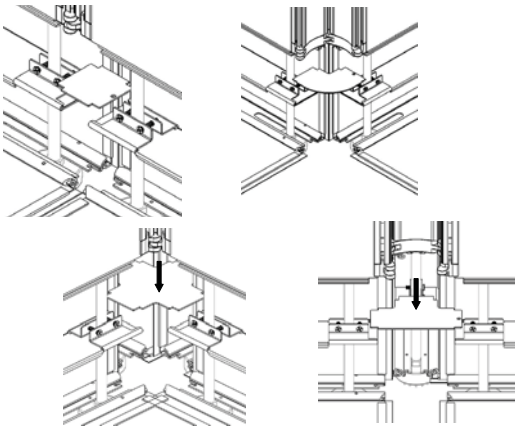

Install Connection Septum's - Install Connection Septum's by simply "resting" septum's on panel septum edges in recessed spaces as shown. Every connection type has a specific Connection Septum.

176

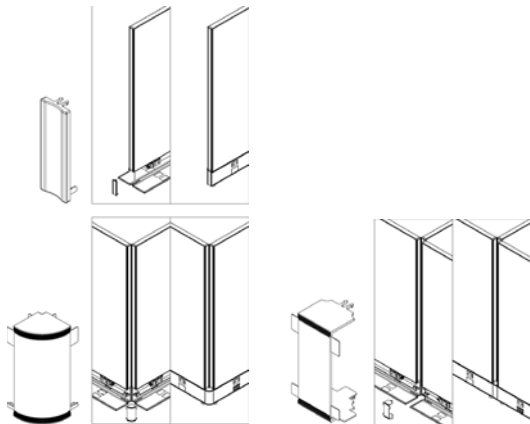

Install Raceway Shrouds – Snap nubs on bottom of shrouds into key slots on bottom of raceway assembly. For Raceway Endcaps and 3-way 90 degree shrouds, snap top prongs into the hooks on underside of alignment plates. Once shrouds are in place, close raceways.

193 Inline Poles

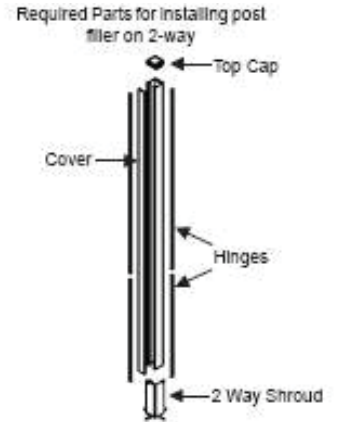
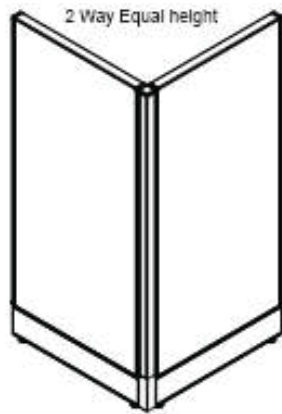

194

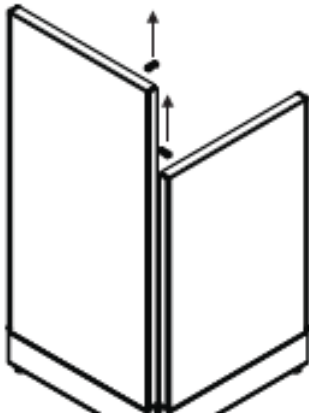

Step 1 - Remove both hanger frame top caps.

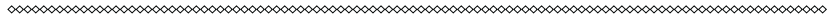

195

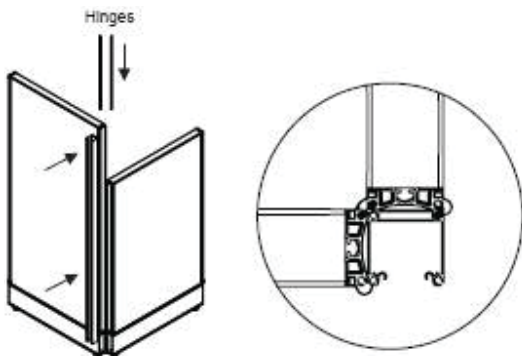

Step 2 - From the side place postfiller body into the 90 degree corner. Hold post filler by installing hinges.

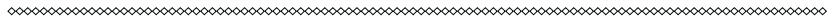

196

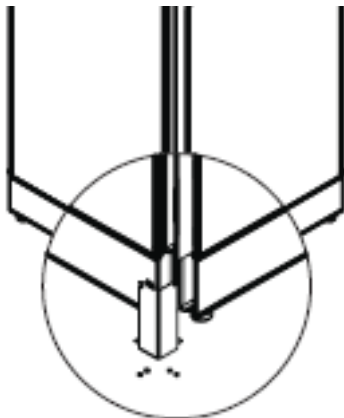

Step 3 - Install 90 degree shroud using the key slots of the bottom member raceway and (4) #6 hex nuts.

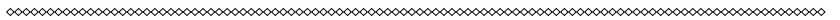

197

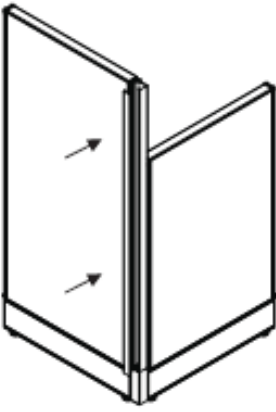

Step 4 - Install postfiller cover.

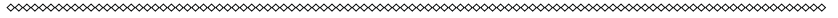

198

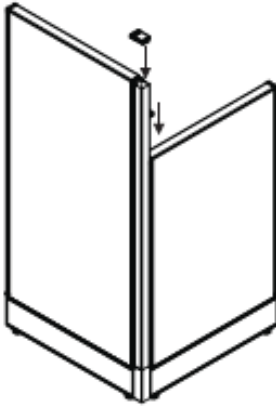

Step 5 - Re-Install hanger frame top caps. Install postfiller topcap.

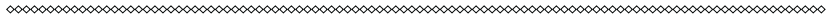

199

Install the 4 locking screws in the Pole Coupler.

IMPORTANT- Make sure screws do not protrude past back surface of the coupler at this time.

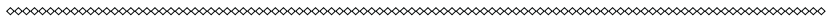

200

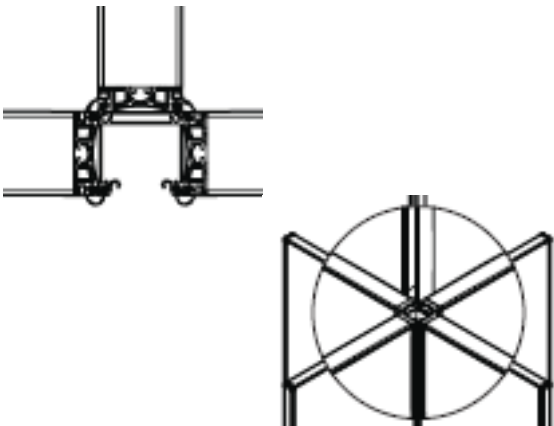

3-Way Poles and 4-Way Poles are installed the same way that 2-way poles are installed. The 3-way will have a different base shroud than the 2-way.

To finish, install the ceiling shroud at the top of the pole.

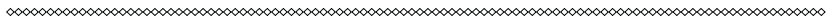

201

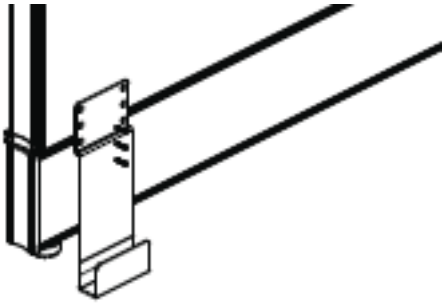

Step 1 - Attach bottom bracket to DiVi hanger frame using 3 #8 11-16 Philips Flat Head Self-Tapping Screws.

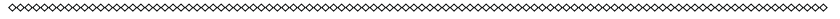

202

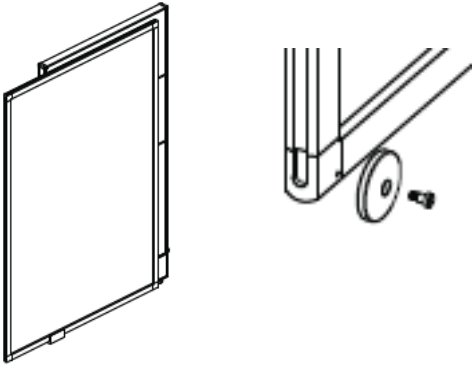

Step 2 - Remove front wheel from the rolling door. Bring door parallel to the panel and check the correct height to attach the top bracket

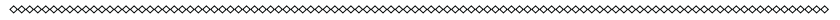

203

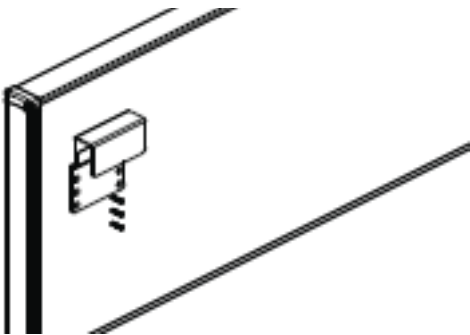

Step 3 - Remove the door from the panel. Attach top bracket to DiVi hanger frame using 3 #8 11-16 Philips Flat Head Self-Tapping Screws.

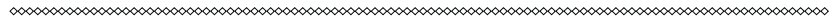

204

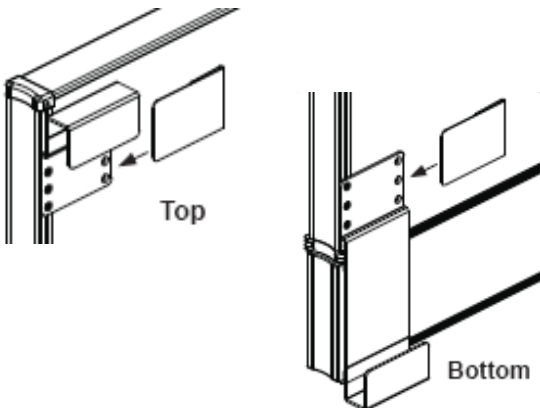

Step 4 - Install metal covers on the door brackets.

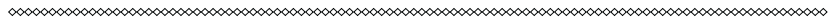

205

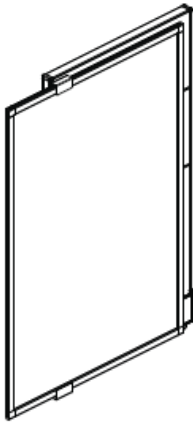

Step 5 - Place door between brackets and slide from back to front.

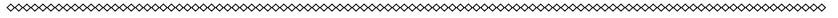

206

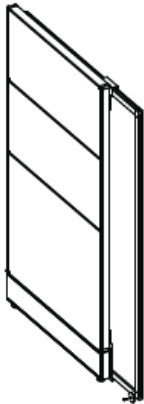

Step 6 - Re-attach front wheel from inside view of door.

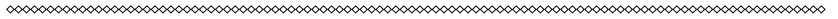

207

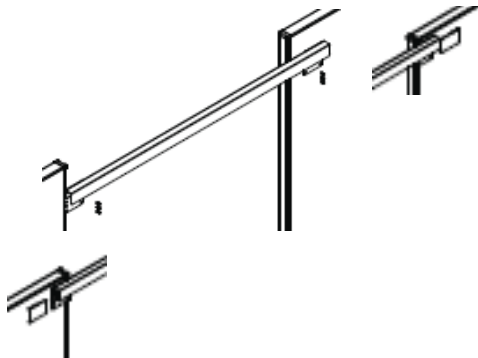

Top Track Bar is only for 82”H Units

Using (6) #8-11/16 phillips flat head self tapping screws, attach top track bar assembly to the hanger frames. Install covers on bottom bracket and top track bar brackets. Covers slide in from the side.

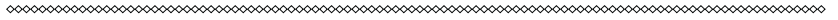

208

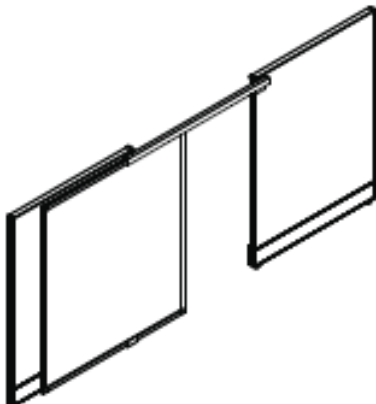

Place door between bottom bracket and top track bar and slide from back to front.

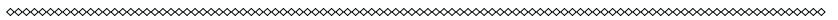

209

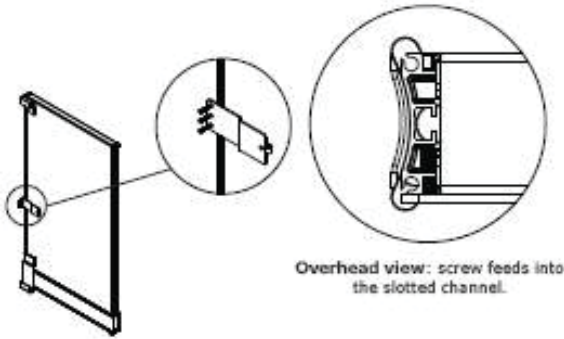

Remove door from panel by removing front wheel and bumper and sliding door out of top and bottom brackets so door is completely off the panel. Using (3) #9-1" flat head screws, attach Lock Bracket to the panels slotted channel at desired height (28" or 29" from floor).

210

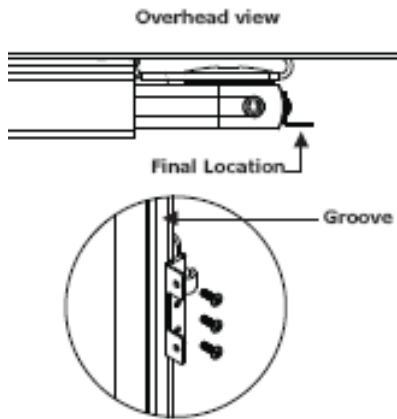

Place sliding door between brackets and slide from front to back. Re-install front wheel and bumper. Using (3) #8-1/2" drill point screws, attach "L" Bracket to groove on the sliding door. Important: "L" Bracket and Lock Bracket must be mounted at same height from floor.

211

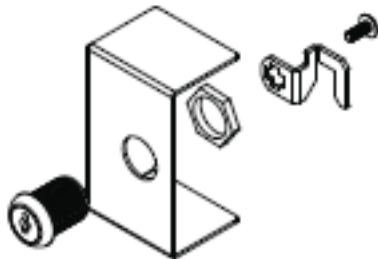

Install Cam and Core Cylinder on Lock Cover.

212

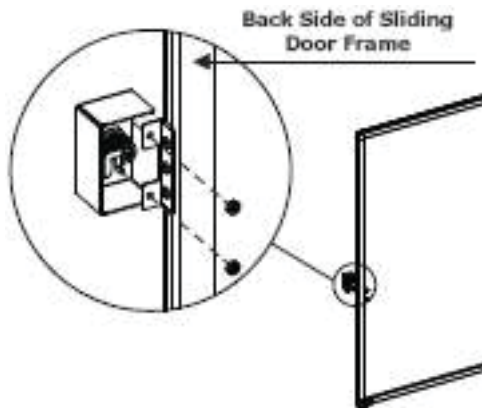

Once again remove door from panel by removing front wheel and bumper and sliding door out of top and bottom brackets so door is completely off the panel. Using (2) #8 hex nuts, install the Lock Cover Assembly to the "L" Bracket.



213

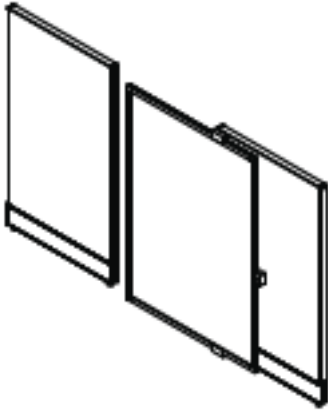

Place sliding door between brackets and slide from front to back. Re-install front wheel and bumper

